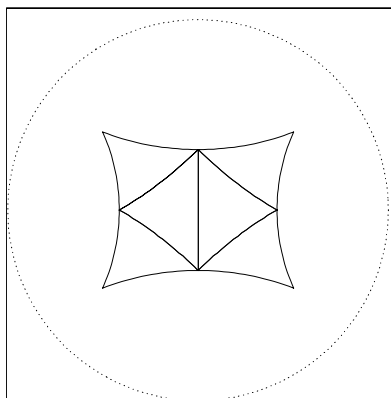
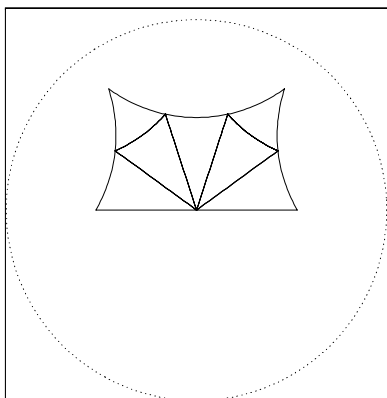

Table 6.6: Divisible quadrilaterals with constrained vertices only



Case C1: $K = 6$,
 $(4, 4, 3) \subset (4, 4, 4, 4)$



Case C2: $K = 7$,
 $(3, 5, 3) \subset (3, 3, 5, 5)$

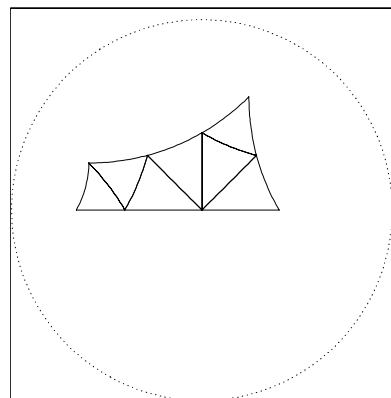

Case C3: $K = 7$,
 $(4, 3, 3) \subset (2, 3, 3, 4)$

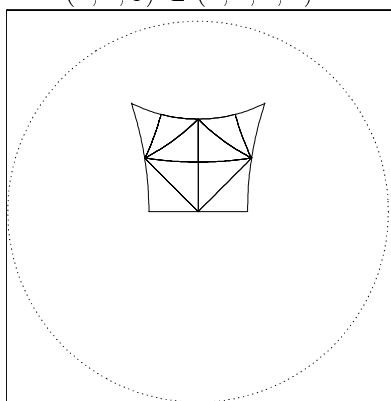

Case C4: $K = 10$,
 $(2, 4, 5) \subset (2, 2, 4, 4)$

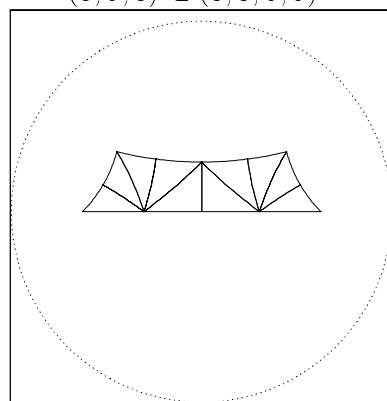

Case C5: $K = 10$,
 $(4, 2, 5) \subset (2, 2, 4, 4)$

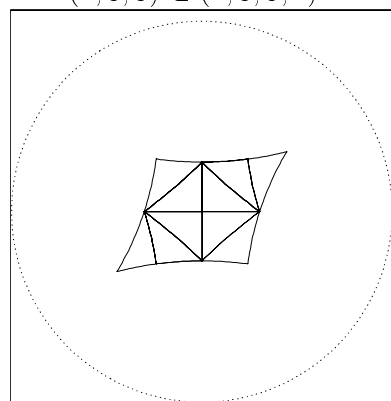

Case C6: $K = 10$,
 $(2, 5, 4) \subset (2, 4, 2, 4)$

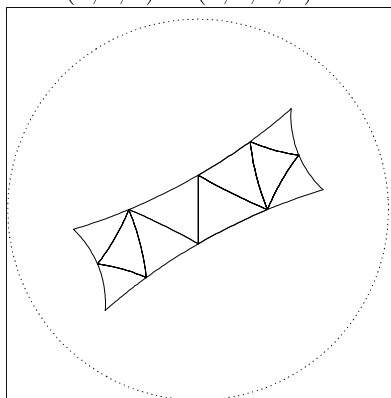

Case C7: $K = 10$,
 $(3, 3, 4) \subset (3, 4, 3, 4)$

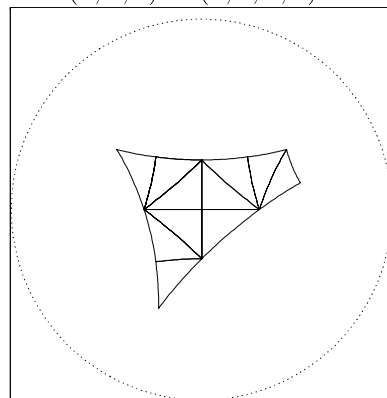

Case C8: $K = 11$,
 $(2, 4, 5) \subset (2, 2, 4, 5)$

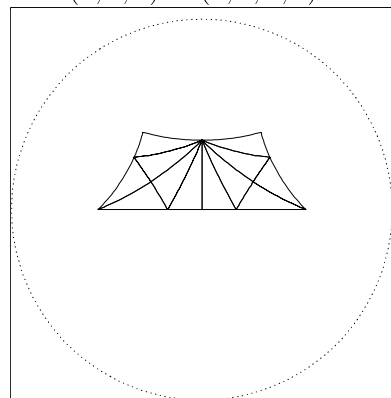

Case C9: $K = 12$,
 $(2, 8, 3) \subset (2, 2, 4, 4)$

Table 6.6 - part 2

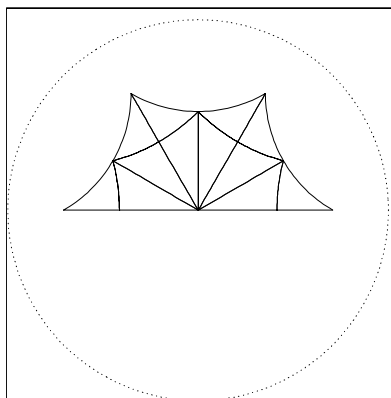

Case C10: $K = 12$,
 $(6, 4, 2) \subset (3, 3, 6, 6)$

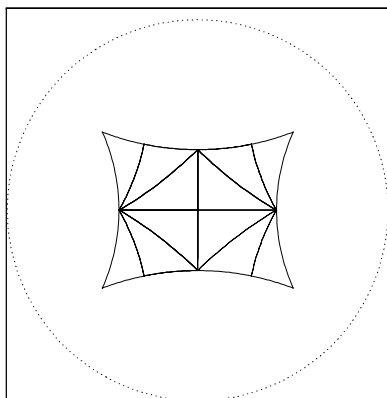

Case C11: $K = 12$,
 $(4, 2, 6) \subset (4, 4, 4, 4)$

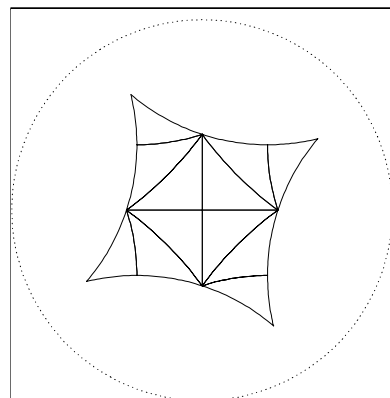

Case C12: $K = 12$,
 $(5, 2, 5) \subset (5, 5, 5, 5)$

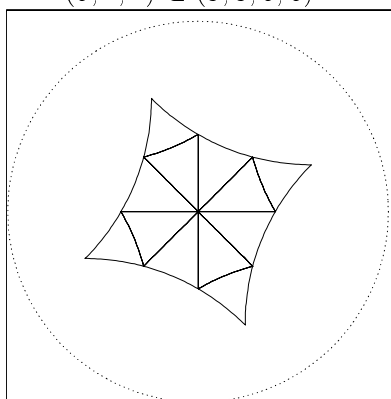

Case C13: $K = 12$,
 $(4, 3, 3) \subset (4, 4, 4, 4)$

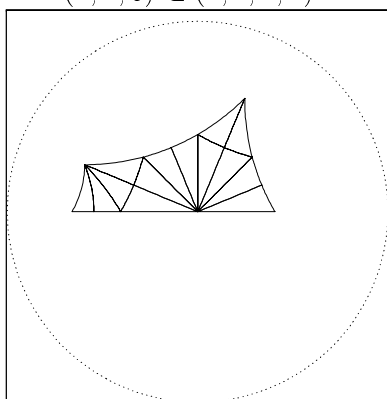

Case C14: $K = 14$,
 $(8, 3, 2) \subset (2, 3, 3, 4)$

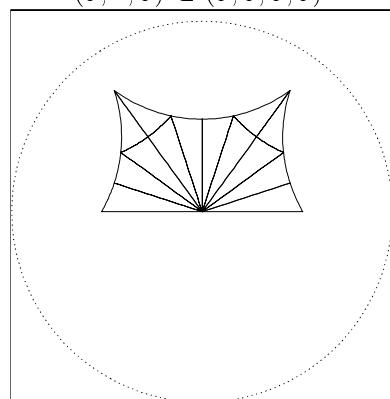

Case C15: $K = 14$,
 $(3, 10, 2) \subset (3, 3, 5, 5)$

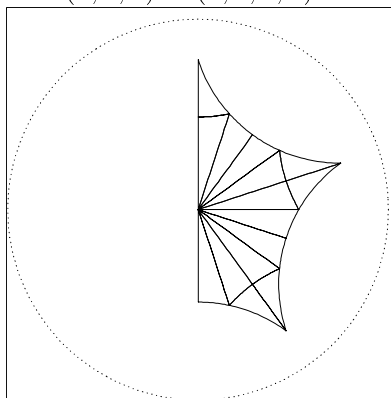

Case C16: $K = 15$,
 $(2, 3, 10) \subset (2, 5, 5, 10)$

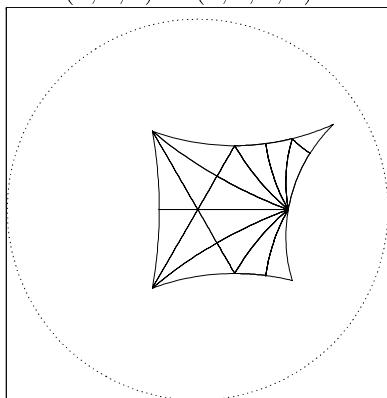

Case C17: $K = 16$,
 $(9, 3, 2) \subset (3, 3, 3, 9)$

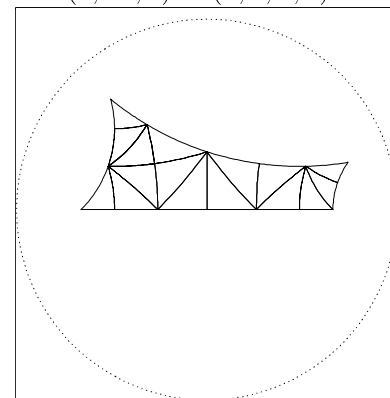

Case C18: $K = 16$,
 $(4, 2, 5) \subset (2, 4, 5, 4)$

Table 6.6 - part 3

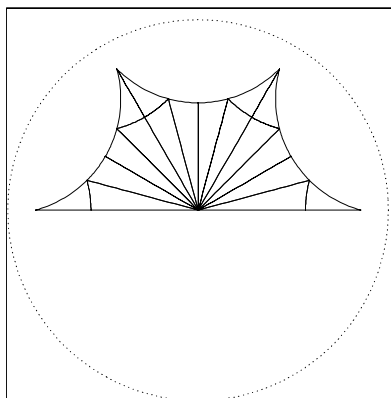

Case C19: $K = 18$,
 $(12, 3, 2) \subset (6, 6, 12, 12)$

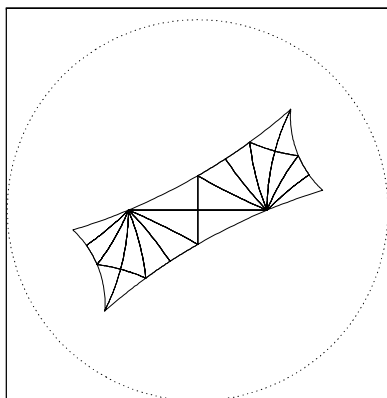

Case C20: $K = 20$,
 $(3, 2, 8) \subset (3, 4, 3, 4)$

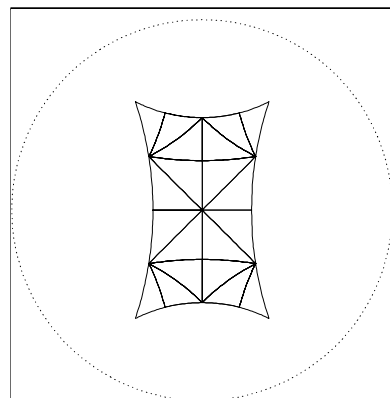

Case C21: $K = 20$,
 $(4, 2, 5) \subset (4, 4, 4, 4)$

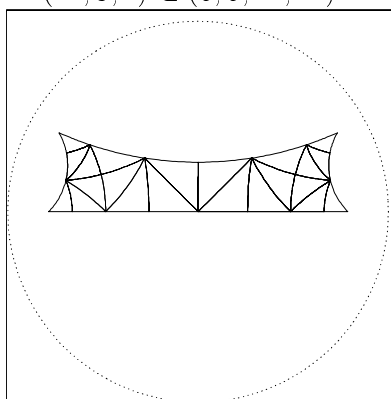

Case C22: $K = 20$,
 $(4, 2, 5) \subset (4, 4, 5, 5)$

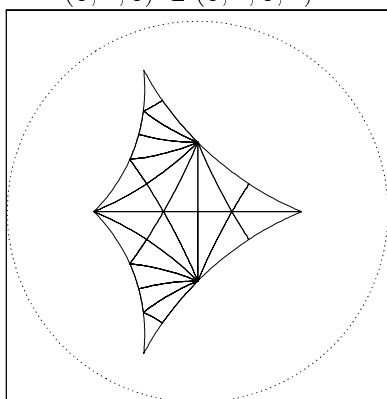

Case C23: $K = 24$,
 $(8, 3, 2) \subset (2, 8, 4, 8)$

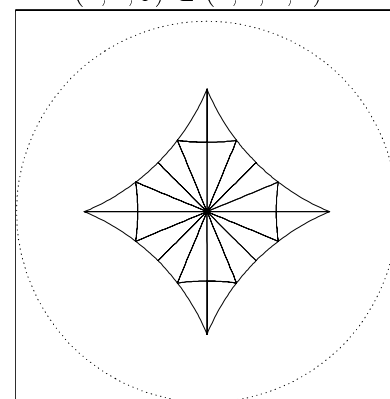

Case C24: $K = 24$,
 $(8, 3, 2) \subset (4, 4, 4, 4)$

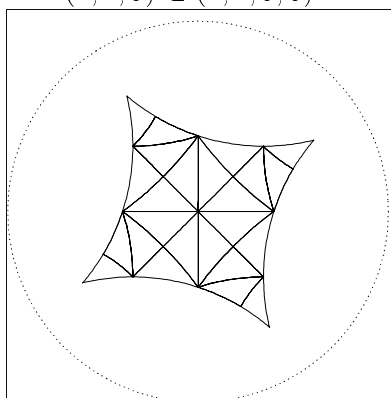

Case C25: $K = 24$,
 $(5, 4, 2) \subset (5, 5, 5, 5)$

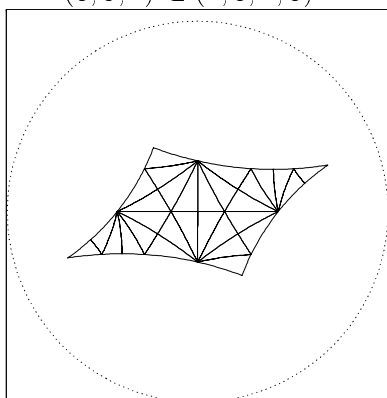

Case C26: $K = 30$,
 $(2, 3, 7) \subset (2, 7, 2, 7)$

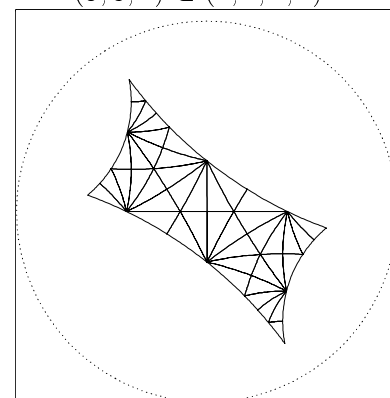

Case C27: $K = 44$,
 $(3, 7, 2) \subset (3, 7, 3, 7)$